

**sigmaPAC<sup>®</sup>**

# Programmable Automation Controller Distributed Automation Solution with Fieldbus

- **Advanced PID control**
- **Logic and batch control**
- **Open connectivity to Most Major Fieldbuses**
- **IEC 61131-3 Programming System**



ISO 9001 Certified

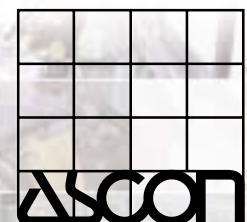

# sigmaPAC® - The late

Automation of machines and systems increasingly requires solutions meeting the following needs:

- Modularity
  - Scalability
  - Geographical and functional distribution
  - Communication standardization
  - Compliance with international standards
  - Reduction in hierarchical levels
  - Easier mounting and cabling
  - Simplified installation and maintenance.
- ASCOS S.p.A., a leading Italian manufacturer in the design and production of industrial automation instruments and systems, supported by its strong presence with OEM and System Integrators and its expertise and long history of innovative technologies, offers SigmaPAC, a powerful and innovative complete control system. Due to its exceptional modularity and flexibility features, SigmaPAC may be used in the most diverse applications.

## One system... many solutions

SigmaPAC offers a vast range of possible configurations:

- A wide variety of I/O modules with autonomous functions and integrated bus interface
- An ability to carry out process control functions and constant, logical and sequential controls
- Personalized libraries of Function Blocks for specific application sectors
- Interface with the most common buses in industrial environments (Modbus, CAN, Profibus, DeviceNet, Ethernet, etc)
- DIN-rail mounting with removable screw or spring terminals
- Possibility to develop centralized or distributed solutions without modifying or adding components.

## Cutting-edge technology

Through the use of the most innovative hardware and software technologies, SigmaPAC allows for even the most demanding control solutions to be developed, integrating different tasks from advanced regulation functions to the management of automation sequences. Communication standardization and integration are guaranteed through the use of widely accepted industry standards - such as fieldbuses, the Ethernet network and serial communications with standard protocols - OPC technologies (OLE for Process Control) and the Internet (Web Server).

SigmaPAC offers a complete development environment, based on languages complying with IEC 61131-3 standards, which guarantee the ease of development and maintenance of automation solutions.

I/O modules



Operator Panels



Controllers (serial devices)



# Best PLC generation



## The first low-cost PAC

SigmaPAC belongs to a new generation of programmable controllers, equipped with great processing capacity, known as PAC (Programmable Automation Controller), and is characterized by:

- "a multi-function platform": equipped with control functions (PID, Auto/Man station management, Autotuning,...) for various types of variables (temperature, pressure, range, level, position,...), logical and sequential functions, process calculations
- "a single development environment" to implement multi-structure functions
- "instruments aimed at designing software architectures" to allow program flows to be defined and multiple parallel tasks to be carried out on the same control unit
- "modular and open architecture" both for industrial applications in the manufacturing industry and for process system automation units
- "maximum connectivity" guaranteed by various interface ports: serial RS 232, 485, Ethernet, fieldbus.

## Comparison table

Features	PLC	SigmaPAC
Dedicated analogue measurement and control	-	Yes
Custom and complex example algorithms	-	Yes
Control algorithms: Advanced PID	-	Yes
Floating point processor	-	Yes
Complete programming tool	Optional	Yes
Ethernet and web connectivity	Optional	Yes
Digital logic	Yes	Yes
Real time OS	Yes	Yes
Industrial temperature range	Yes	Yes
Shock and vibrations resistant	Yes	Yes

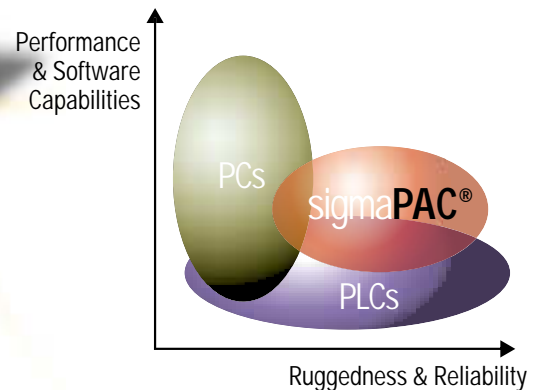

# sigmaPAC® ...centralized or di

## SigmaPAC is here!

One of the characteristics of SigmaPAC is its architecture which enables the complete distribution of signal interface units. The adoption of a standard fieldbus as its system bus allows standard third party devices (transducers, actuators and operator interfaces) to be connected and controlled directly by the SigmaPAC Central Unit.

## Centralized or distributed... for us it's all the same

Through the adoption of a high-efficiency standard protocol, the performance of SigmaPAC is not "penalized" if the architecture required is distributed. The I/O modules may be located directly next to the measurement or control points without the use of further interface devices.

## Geographical and functional distribution

The onboard intelligence residing in each module allows basic processing to be distributed, and relieves the Control Unit from trivial repetitive operations. Power-up and power-down functions allow the state of the output variables to be determined upon start-up or in the event of an interruption.

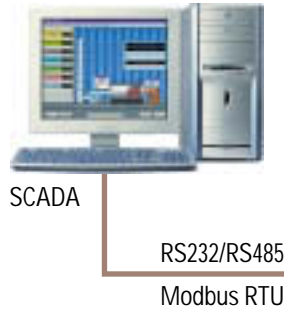

## Centralized or Distributed Solutions



## Sincronized Automation Cells

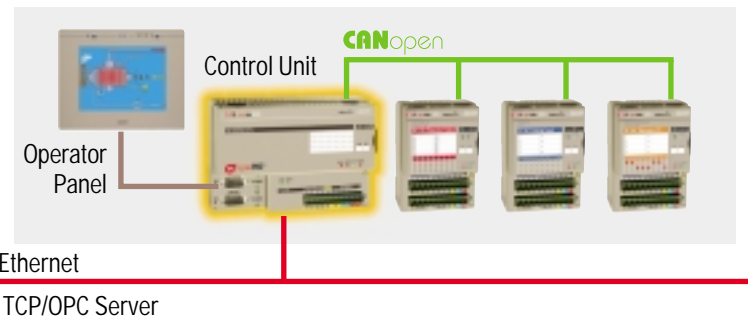

## Open and Integrated Architectures

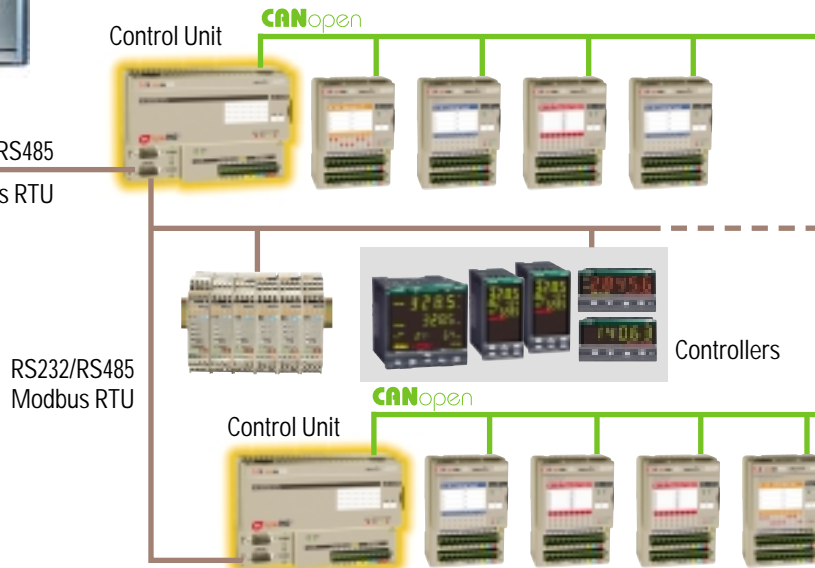

## Industries and Applications

**Plastic and Rubber:** Injection, Extrusion, Hot-Runners  
**Packaging:** Thermowelding, Thermoforming

**Food:** Dairy products, Food Packaging, Bottling, dried and fresh Pasta, oven Products, cereal Silos, preserving-ripening stores

**Vehicles:** engine testing Counters, painting Plants, plate welding Plants  
**Ceramic and Brick Works:** continuous Furnaces, intermittent Furnaces, Driers



# distributed... the same solution!

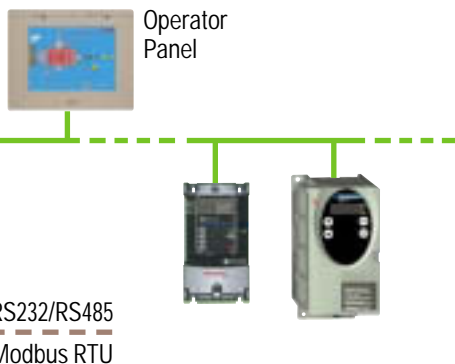
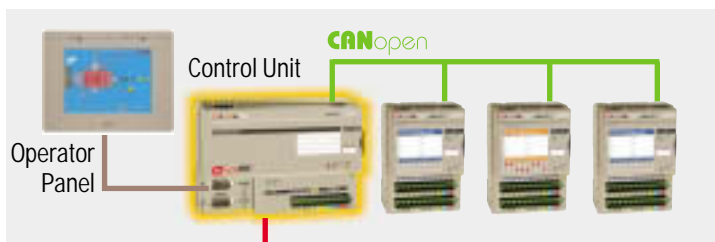

## Synchronized... islands of automation

The automation of part of the system or machines may be managed independently by a Control Unit connected to a number of I/O modules.

It is possible to use secondary communication ports available on the Control Unit to exchange synchronism data or messages with other units in different areas. To this end, it is possible to choose whether to use the serial ports RS232/485 with Modbus protocol (the Master/Slave mode may be configured on each port), or to use other fieldbuses such as Profibus Dp, DeviceNet or CANopen.

## "Single click" connection

The advantage in terms of reduced cable and cabling needs, as well as the indirect reduction in engineering activities required by the system or automated machine is significant.

The Control Unit and the I/O modules are connected by standard CAT5 Ethernet cables.



**Metal Works:** blast Furnaces, thermal treatment Furnaces  
**Glass:** blast Furnaces; Furnaces for the treatment of flat, hollow, curved glass

**Chemistry and Pharmaceuticals:** Fine chemistry, Pharmaceuticals, Cosmetics, Paints and Enamels  
**Power:** Boilers, Burners

**Industrial Air Conditioning and Refrigeration:** climatic Chambers, Chillers  
**Shipyards:** hull Automation  
**Water Treatment:** waste Waters, Primary Waters, Semi-Conductors.



## Standard IEC 61131-3 programming

The OpenPCS programming environment allows applications to be created in the 5 programming languages that comply with international standard IEC 61131-3 (Instruction List, Structured Text, Sequential Function Chart, Function Block Diagram, Ladder Diagram).

## OpenPCS Automation Suite

The multitasking programming environment allows the project to be split into different tasks, executed sequentially or on the basis of a time cycle.

The variable declaration window guides users towards structured programming. The 5 language editors aid in the correct execution of the application, automatically highlighting the keywords in the textual languages, and allow the function menus to be accessed rapidly.

The diagnostics window allows any errors to be immediately identified during the project compilation phase.

Powerful and complete online debugging tools and useful off-line simulation allow the code to be verified from a functional point of view.

Furthermore, the integrated OPC server tool permits immediate connection with standard third party SCADA software.

Project management is facilitated by integrating documentation files in various formats in the specific Project-browser folder.

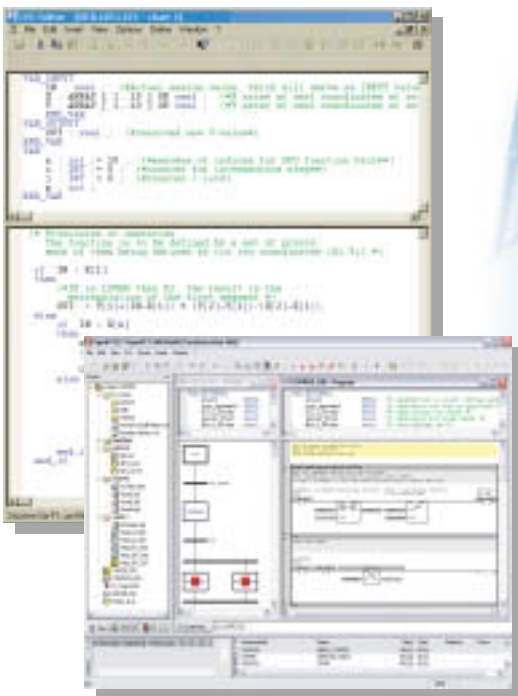
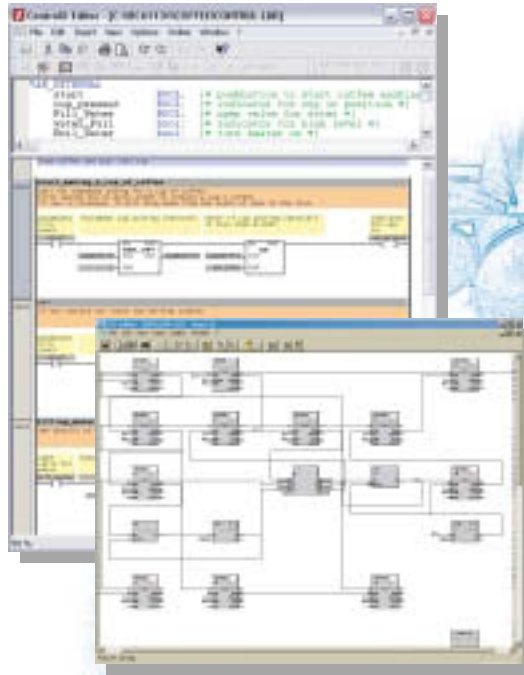

# 131-3... and more

## Vast function libraries... to aid programming

Three libraries contain numerous function blocks for rapid and effective achievement of control and sequence routines.

### Ascon Control Library

- PID with advanced functions
- Automatic/Manual output
- Autotuning function
- Heat/Cool algorithms (with overlap)

### Ascon Auxiliary Library

- SetPoint programmer
- $F_o$  calculation
- Simplified reading/writing for network Operator Panels
- Moving average calculation
- Function block aimed at Modbus RTU and TCP communications
- Functions for accessing the Real time clock
- Functions for setting the Watchdog and the Wake Up Alarm
- ....

### Ascon I/O Library

Includes Function Blocks aimed at configuring, exchanging data and activating advanced functions in the I/O modules.

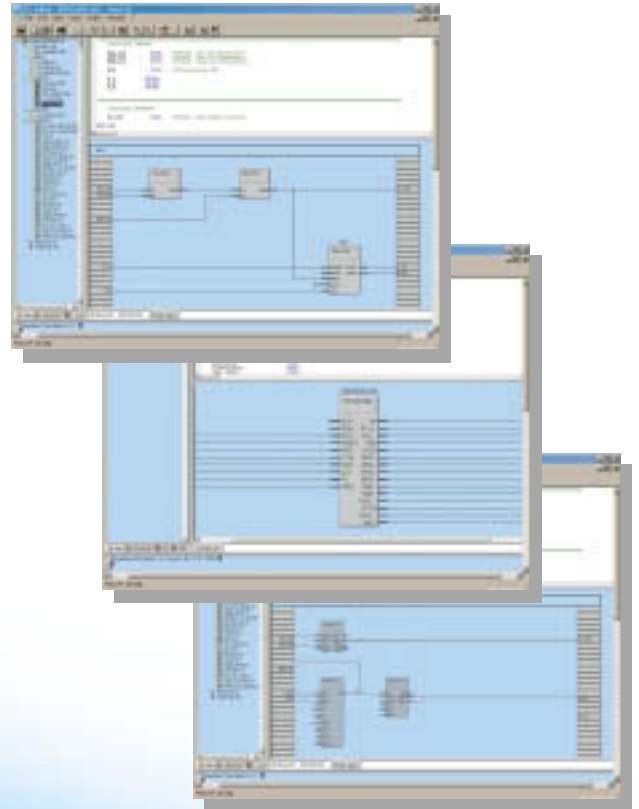

```
BOOL: (* ...
BOOL: (* ...
BOOL: (* ...
bool: (* ...
bool: (* ...
```

## Numerous programming examples ... to speed up development

Ascon offers numerous application examples such as boiler control, autoclaves, furnaces, plastic processing, etc.

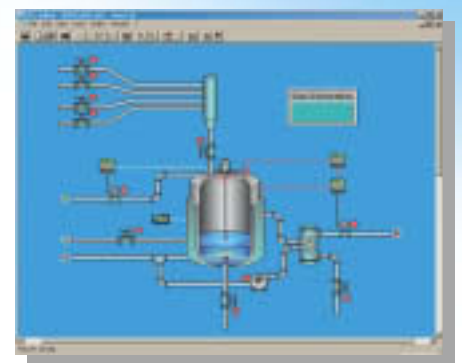
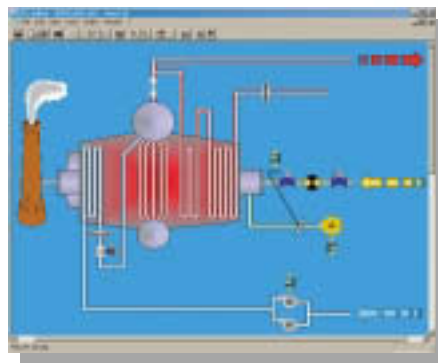
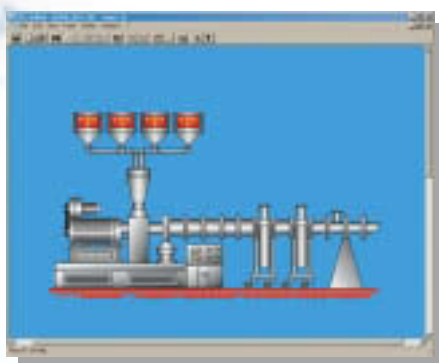

# sigmaPAC<sup>®</sup> - Open connectivity

## Open connectivity

The Control Unit integrates different interface ports with standard communication protocol:

### CANopen port

This port interfaces I/O modules and other CANopen devices like Operator Panels, Inverters, Motors, Valves...

### Ethernet port

Primarily used for:

- Control Unit programming with OpenPCS
- HMI connection via the commonly used Modbus TCP protocol
- SCADA connection with the OPC server. OPC (OLE for Process Control) is a standard method available on most OPC client SCADA systems, and allows devices to be connected without writing any driver or communication code.

### Serial RS 232

System port for:

- Setting up the Control Unit
- Ethernet port configuration
- Setting up the CANopen port parameters.

Every Control Unit can be equipped with optional fieldbus ports to interface other systems:

- Serial RS232+RS485 with Modbus RTU protocol (Master or slave software configurable). Operator Panels, SCADA or external devices can be connected.
- Profibus DP slave for PLCs or Operator Panels.
- CANopen slave for communication with other control units.

### Integrated Web server ... for immediate connection

SigmaPAC offers the opportunity of viewing and modifying significant process data through the integrated Web server. Up to 200 different variables may be viewed simply and directly with common internet browsers. No programming or supervision software is required.

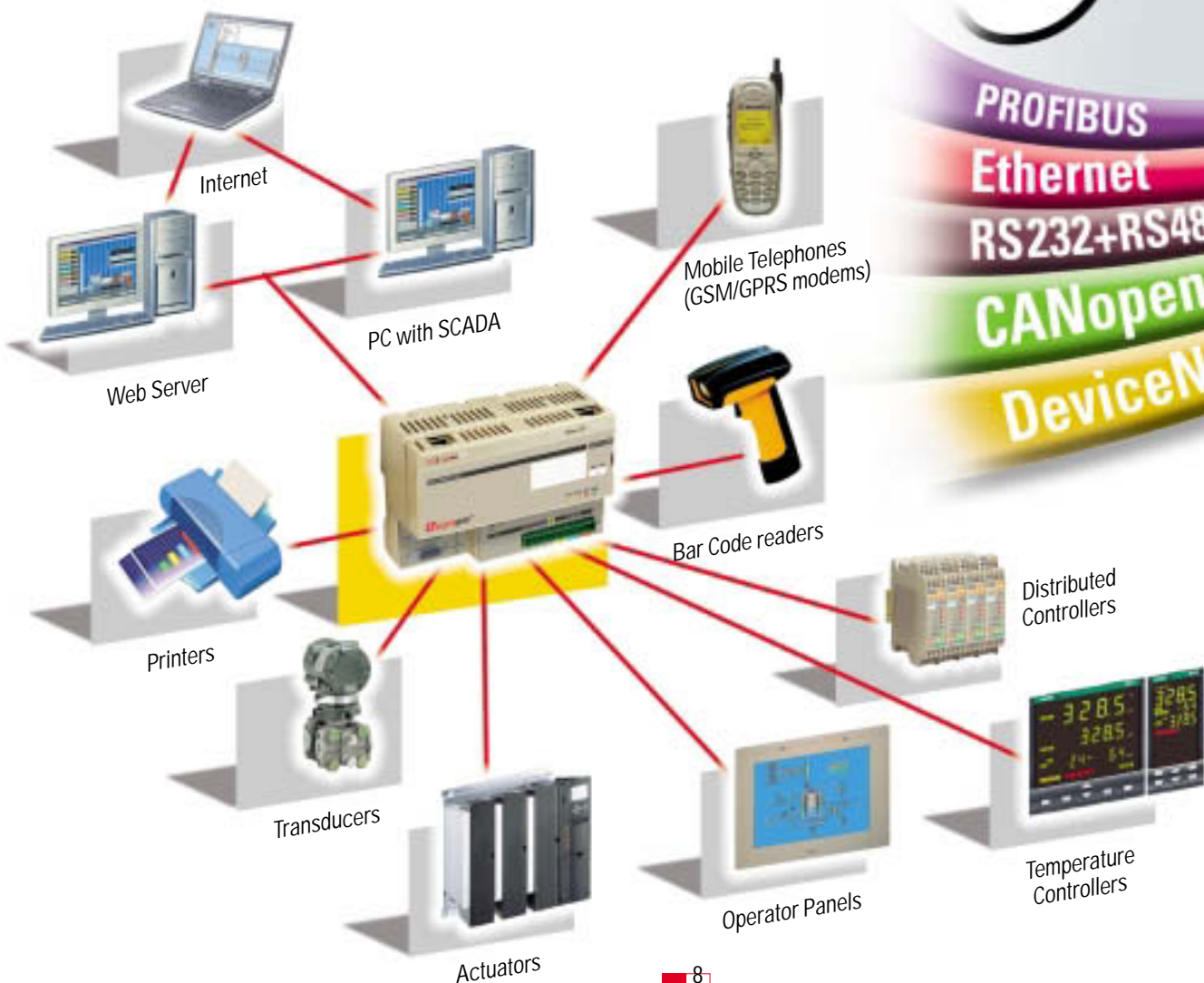



# Compatibility to most major fieldbuses

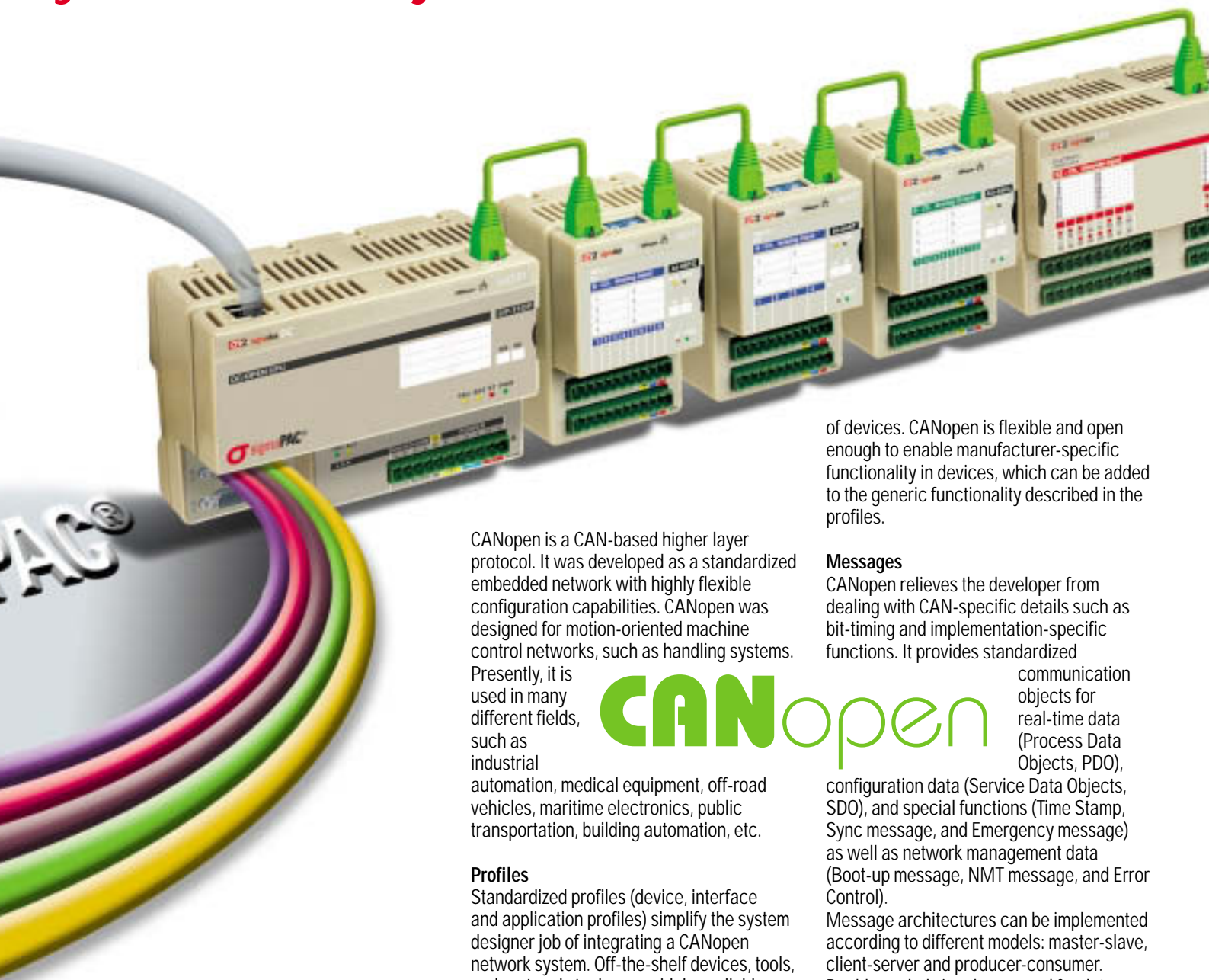

CANopen is a CAN-based higher layer protocol. It was developed as a standardized embedded network with highly flexible configuration capabilities. CANopen was designed for motion-oriented machine control networks, such as handling systems. Presently, it is used in many different fields, such as industrial automation, medical equipment, off-road vehicles, maritime electronics, public transportation, building automation, etc.

### Profiles

Standardized profiles (device, interface and application profiles) simplify the system designer job of integrating a CANopen network system. Off-the-shelf devices, tools, and protocol stacks are widely available at reasonable prices. For system designers, it is very important to reuse application software. This requires not only the communication compatibility but also the interoperability and interchangeability

of devices. CANopen is flexible and open enough to enable manufacturer-specific functionality in devices, which can be added to the generic functionality described in the profiles.

### Messages

CANopen relieves the developer from dealing with CAN-specific details such as bit-timing and implementation-specific functions. It provides standardized communication objects for real-time data (Process Data Objects, PDO), configuration data (Service Data Objects, SDO), and special functions (Time Stamp, Sync message, and Emergency message) as well as network management data (Boot-up message, NMT message, and Error Control). Message architectures can be implemented according to different models: master-slave, client-server and producer-consumer. Double-ended signals are used for data transmission at different baud rates (up to 1 Mb), depending on the length of the network. CANopen takes care of error detection and diagnostic services.

## CANopen

### Automation Network

Ascon Spa is part of Automation Network, a business-to-business platform that associates the Companies that use OpenPCS IEC61131-3 software integrated to their products. This allows all members to complement their range of products with compatible products from other members. This, in turn, allows the members' products to be offered on markets that were previously not accessible to individual companies. In addition, every

company has access to a complete range of products in its local market from the Automation Network Companies, which in turn enables successful competition against the products of a full-line major supplier. There are already more than twenty "Automation Network" member companies, and these are convinced that the future lies in a new, synergistic business model matching typical component suppliers with service providers in a network of independent

companies capable of offering a broader global spectrum of solutions and products to their local customers. Members are from Italy, Sweden, France, Switzerland, Germany, Austria, USA, Canada, China and Taiwan.

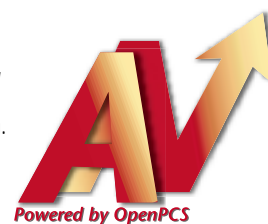

# sigmaPAC®

## All you need

### Control Unit

Programmable Automation Controller IEC 61131-3 compliant.



### I/O Modules

Wide range of modules for analogue, digital, relay input/output signals.

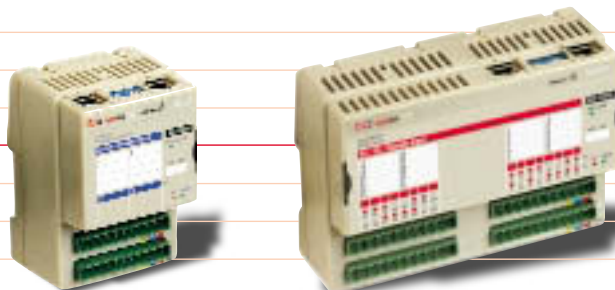

### Open PCS Automation Suite Ascon Edition

Complete programming environment according to IEC 61131-3 standard with Ascon Function Libraries.

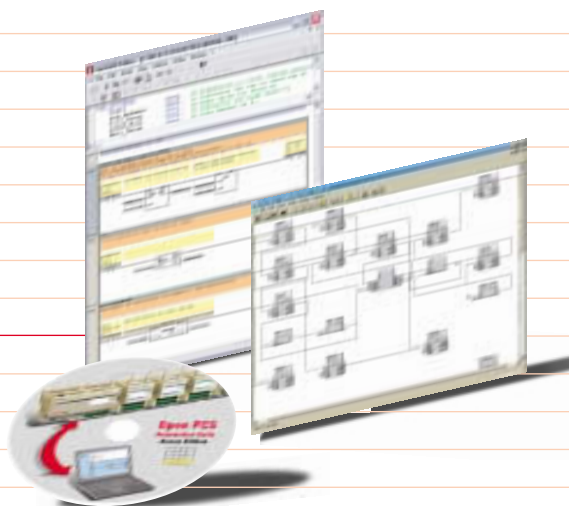

### Operator Panels

Colour and monochrome touch screen panels for local HMI with different sizes.

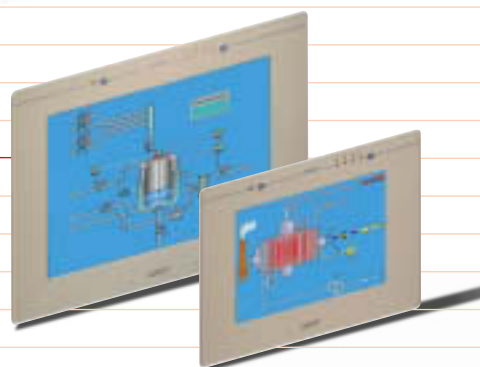

### Accessories

#### Autolink

Standard SCADA software for local and remote HMI with trends, logs, alarms, etc...

#### CANopen configurator

Standard software for network configuration and data analysis.

#### Power supply

Various sizes available.

#### Additional terminal block

To make local cabling easier.

#### CANopen RJ45 cables

For a "single click" connection of network devices.

#### Termination connectors

For CANopen network termination.

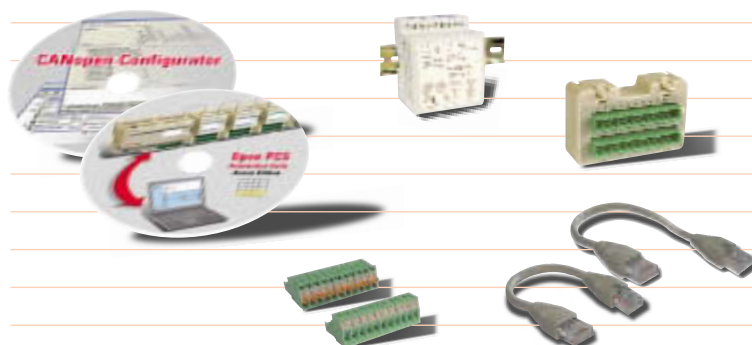

# Control unit



## Characteristics

<b>Processor</b>	32 bit processor, ARM architecture
	4 Mbyte Flash Memory
	16 Mbyte DRAM
	128 Kbyte SRAM with battery Back-up
<b>Default interfaces</b>	CANopen port (RJ45 connector, CiA definition)
	Ethernet 10baseT port (Modbus TCP, OPC server)
	RS232 port
<b>I/O on board</b>	Configurable alarm relay digital output
	Watchdog and Wake Up digital output
	One Digital input available
<b>Optional interfaces</b>	Serial ports RS232 and RS485 with Modbus RTU protocol (Master/slave config.)
	Profibus DP slave
	CANopen slave
	DeviceNet slave

The Control Unit offers a high degree of flexibility. It can function as a slave device on a Modbus RTU, Modbus TCP, CANopen, Profibus network, and act as CANopen master on the underlying CANopen system (I/O modules and third party devices). Thus the Control Unit is the ideal device for modular systems with distributed control architecture. With integrated industry standard open communications, the Control Unit makes it possible to easily communicate with decentralized I/O nodes or other PLCs.

## Programming and Supervision

The Control Unit comes equipped with OpenPCS software including drivers for Ethernet or serial interface for an unlimited number of applications.

Ethernet is used both for programming and supervisory functions. OpenPCS running on a PC can be connected through the Ethernet port to download the control application and debug the program online.

## CANopen Configuration

The CANopen network may be set up in one of two ways:

- Ascon I/O Library
- Standard CANopen Configuration software

In both cases, all slave settings are stored in the non-volatile memory of the Control Unit. When the Control Unit is started, all slave nodes are automatically configured.

## Integrated Features

An embedded real time clock manages task scheduling and event handling.

Special functions, such as Watchdog or Wake Up alarms, are available to control the correct functionality of a SigmaPAC system, and can be used by external devices for security purposes.

## Dimensions

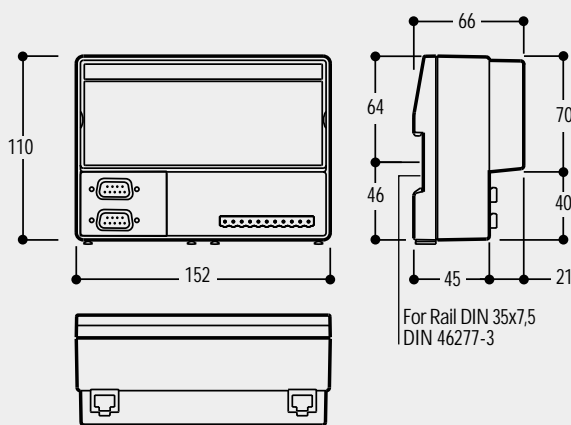

## Features

<b>Electrical</b>	
Power Supply	24Vdc nominal (min 18V, max 30V)
<b>Environmental</b>	
Operating temperature	-0..+55 °C standard
Storage temperature	-20..+85 °C
Relative humidity	5..95%, non condensing
Vibrations resistance	IEC 60068-2-6
Shock resistance	IEC 60068-2-27
<b>General</b>	
Mounting	on DIN rail, vertical, free air
Protection degree	IP20
CE Marking	EN 50081-2, EN 50082-2, EN 61010

## SigmaPAC

<b>CU-01NB</b>	4Mb flash, 16Mb RAM, Ethernet 10T port, CANopen RJ45 port, RS232 RJ45 port
<b>CU-01SB</b>	4Mb flash, 16Mb RAM, Ethernet 10T port, CANopen RJ45 port, RS232 RJ45 port, + 2 Serial (DB9 ports): RS232, RS485
<b>CU-01PB</b>	4Mb flash, 16Mb RAM, Ethernet 10T port, CANopen RJ45 port, RS232 RJ45 port, + Profibus DP (DB9 port)
<b>CU-01CB</b>	4Mb flash, 16Mb RAM, Ethernet 10T port, CANopen RJ45 port, RS232 RJ45 port, + CANopen (DB9 port)
<b>CU-01DB</b>	4Mb flash, 16Mb RAM, Ethernet 10T port, CANopen RJ45 port, RS232 RJ45 port, + DeviceNet (DB9 port)

# sigmaPAC® - Remote I/O modules for

## Remote I/O modules for effective distributed automation

Each module has embedded fieldbus interface and power supply; therefore the modules can be distributed along the plant or on board of machines, in order to reduce engineering, mounting and wiring costs.

## Multifunction modules for high flexibility

Through software configuration, sigma<sup>due</sup>® I/O modules can be used for different purposes. For example a module can be used at the same time for state and counter inputs, state and PWM outputs. Some sigma<sup>due</sup>® modules boast universal analogue inputs and can be configured for different sensors. The availability of 8, 16 and 32-channel modules provides great flexibility, fitting many different applications.

## Processing capability on board

The embedded microprocessor allows local signal conditioning and data handling, such as linearisation, data scaling, engineering units conversion, alarm handling, etc. . .

This relieves the Control Unit from a considerable load of computing power, thus improving performance and bus efficiency.

## High performances

Accuracy class: 0,1%, and 16 bit resolution for analogue I/O. Analogue sampling: from 5ms max total conversion time. Transfer of input data on fieldbus network: 5ms max for all I/O.

## Easy installation and Quick Wiring

- Bus Connection: two RJ45 connectors on each module for fast hot swap
- Removable terminal block plugs
- Screw or spring clamp type plugs
- Additional Terminal Block available to make an easier wiring of field signals just added by a "click".

## Fieldbus technology

- Built-in fieldbus interface for CANopen.
- CANopen is successfully employed in many industrial control systems: the very flexible applications layer and many optional functionalities perfectly match network designer needs.

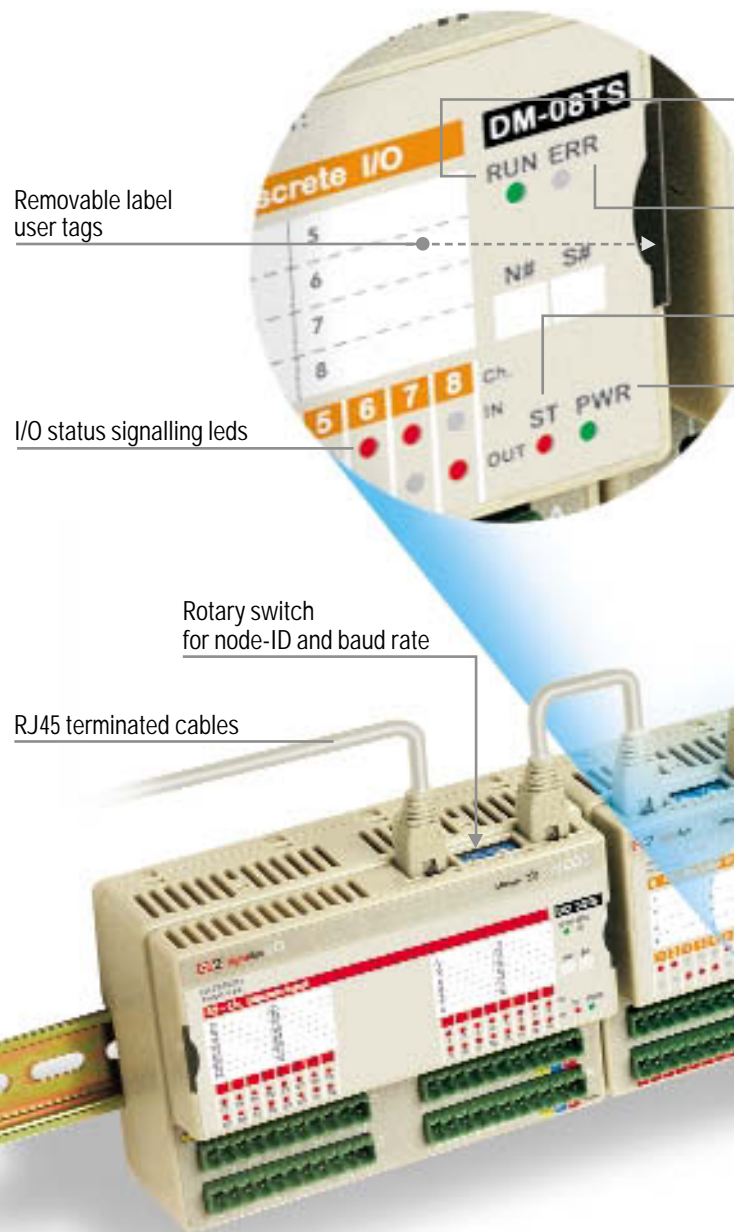

Removable label user tags

I/O status signalling leds

Rotary switch for node-ID and baud rate

RJ45 terminated cables

## Analogue modules

Model	Ch.s	Inputs	Outputs	Resolution class	Isolation class	Accuracy	Acq. time	Functions	Remarks
AI-02UI	2	Universal: RTD, TC, mA, mV, V, Potentiometer		16bit	2500V	0.1%	20ms	Linearisation Scaling Engineering Units Limits Autotare Autozero	Isolation between the two inputs High accuracy High Speed
AI-08TC	8	TC, mV		16bit	800V	0.1%	60ms	Linearisation Scaling Engineering Units Limits	Differential inputs
AI-04RT	4	RTD, TC, mV		16bit	800V	0.1%	120ms	Linearisation Scaling Engineering Units Limits	
AI-08HL	8	mA, V		16bit	800V	0.1%	10ms	Limits Offset, scaling	Fast acquisition
AI-08DP	8	mA, V Dual Polarity		16bit	800V	0.1%	10ms	Limits Offset, scaling	Fast acquisition
AO-08HL	8		mA, V	16bit	800V	0.1%	20ms	Limits	High accuracy High Speed
AO-08DP	8		mA, V Dual Polarity	16bit	800V	0.1%	20ms	Limits	High accuracy High Speed

# or effective distributed automation

LED name	Status	Meaning
RUN	ON	Operational
	Blinking	Pre-operational (CANopen)
	Single flash	STOPPED
	OFF	Device in RESET state
ERR	ON	BUS OFF
	Single flash	Warning limit reached
	Double flash	Error Control Event
	Triple flash	Sync Error (CANopen)
ST	OFF	No error. Device working
	ON	DIAG Error
	Blinking	INIT and DIAG running
	Single flash	Baud rate setting
PWR	OFF	Module OK and ready
	ON	Module Power Supply ON
	OFF	Module Power Supply OFF

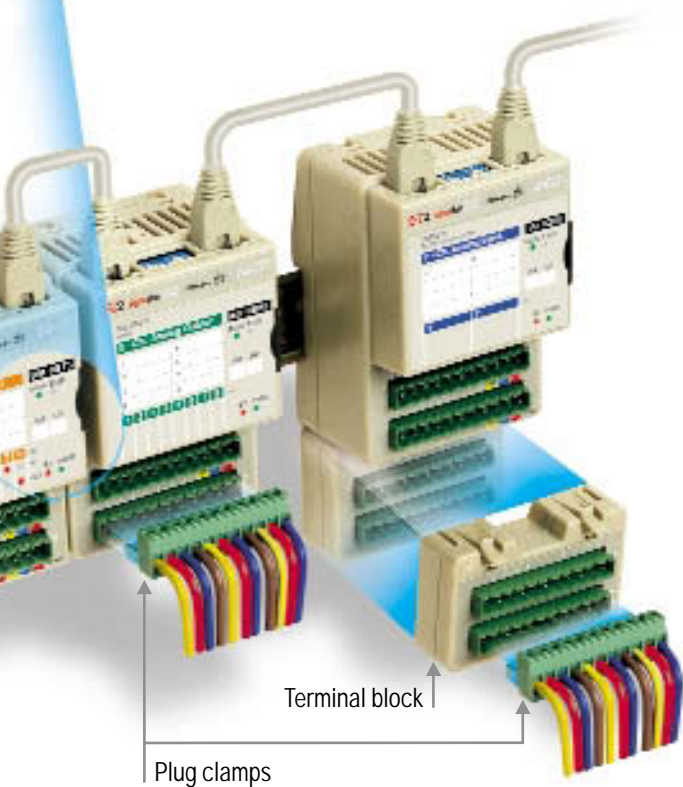

## Common Features

<b>Electrical</b>	Power Supply: 24Vdc nominal (min 18V, max 30V) Three ways isolation: I/O to Logic - Logic to Fieldbus Power Supply to all circuits
<b>Environmental</b>	Operating temperature: -10..+65 °C standard -20..+70 °C extended Storage temperature: -40..+85 °C Relative humidity: 5..95%, non condensing Vibrations (3 axes): 10..57Hz, 0.0375 mm / 57..150Hz, 0.5g Shock (3 axes): 15g, 11ms half sine
<b>General</b>	Mounting: on DIN rail, vertical, free air Protection degree: IP20 CE Marking: EN 50081-2, EN 50082-2, EN 61010

## Dimensions

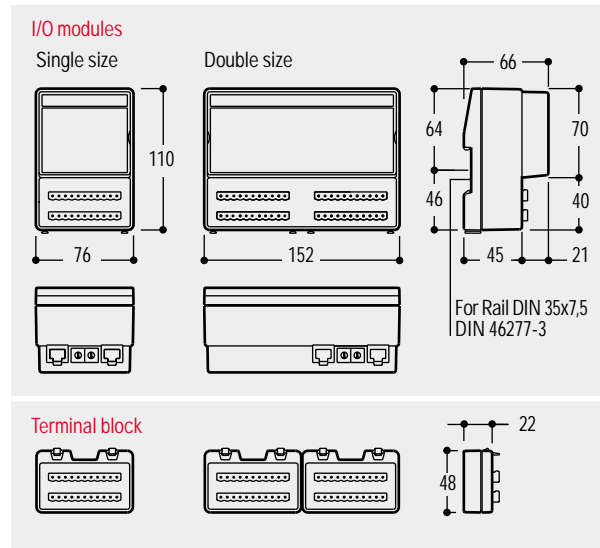

## Digital modules

Model	Channels		Size	Input Voltage	Output Voltage	Output Current	Isolation Class	Functions					Remarks
	I	O						Counters	Edge detect	Latch	PWM	Pulse	
DI-16LV	16		Single	24Vdc		-	800V		✓	✓			Optoisolated Sink (PNP)
DI-32LV	32		Double	24Vdc		-	800V		✓	✓			Optoisolated Sink (PNP)
DO-16TS		16	Single		24Vdc	0.5A	800V					✓	High Side Transistor
DO-16TP		16	Single		24Vdc	2A	800V					✓	High Side Transistor
DO-32TS		32	Double		24Vdc	0.5A	800V						High Side Transistor
DO-04RL		4	Single		250Vac	2A (SPST) 1A (SSR)	4000V					✓	SPST Relay SSR Relay
DO-08RL		8	Double		250Vac	2A (SPST) 1A (SSR)	4000V					✓	SPST Relay SSR Relay
DM-08TS	8	I/O	Single	24Vdc	24Vdc	0.5A	800V	✓	✓	✓	✓	✓	Optoisolated Sink (PNP) Input or/and High Side Trans. Output
DM-16TS	8	8	Single	24Vdc	24Vdc	0.5A	800V		✓	✓			Optoisolated Sink (PNP) Input or/and High Side Trans. Output
DM-32TS	16	16	Double	24Vdc	24Vdc	0.5A	800V		✓	✓			Optoisolated Sink (PNP) Input or/and High Side Trans. Output
DO-04TX		4	Single		24Vdc	6A	800V					✓	High Side Transistor

# sigmaPAC® Accessories

## Operator Panels

A variety of Operator Panel sizes are available.

Connection to SigmaPAC system via:

- 1) Serial RS485 (Modbus RTU driver embedded)
- 2) CANopen with optional interface board.

### OP39

- 64K color 10.4" TFT display
- VGA (640x480 pixel) resolution
- Resistive touch screen
- Connection to industrial bus systems and Ethernet (requires plug-in modules)
- 32 MB internal Flash memory
- 32 MB on removable media (option)
- SSFDC memory card
- Programmable with "Designer" software tool (option)
- IP65 front panel protection
- Dimensions (mm): Front 287 x 232 x 5
- Cutout (mm): 276 x 221 - Cutout depth 91.

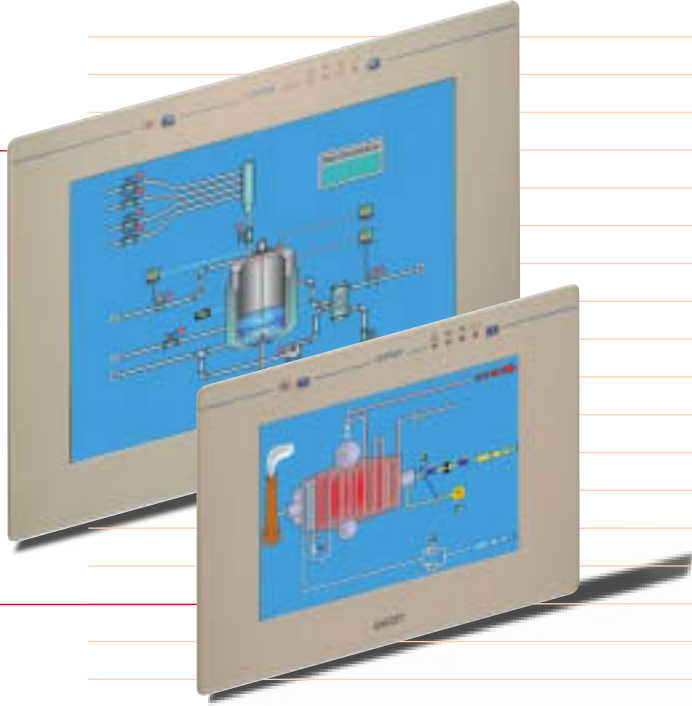

### OP37

- 64K color 7.5" TFT display
- VGA (640x480 pixel) resolution
- Resistive touch screen
- Connection to industrial bus systems and Ethernet (requires plug-in modules)
- 32 MB internal Flash memory
- 32 MB on removable media (option)
- SSFDC memory card
- Programmable with "Designer" software tool (option)
- IP65 front panel protection
- Dimensions (mm): Front 232 x 187 x 5
- Cutout (mm): 221 x 176 - Cutout depth 74.



### OP35

- 5.6" Monochrome display with long-life LED backlight
- 1/4 VGA (320x240 pixel) resolution
- Resistive touch screen
- Connection to industrial bus systems and Ethernet (requires plug-in modules)
- Large memory size (8 MB Flash) on removable media
- Programmable with "Designer" software tool (option)
- IP65 front panel protection
- Dimensions (mm): Front 187 x 147 x 5
- Cutout (mm): 176 x 136 - Cutout depth 79.

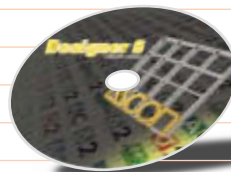

### Designer Ascon Edition

The operator panel configuration allows customized viewing of process variables, the creation of graphic pages, alarm management schedules and integrated system macros.

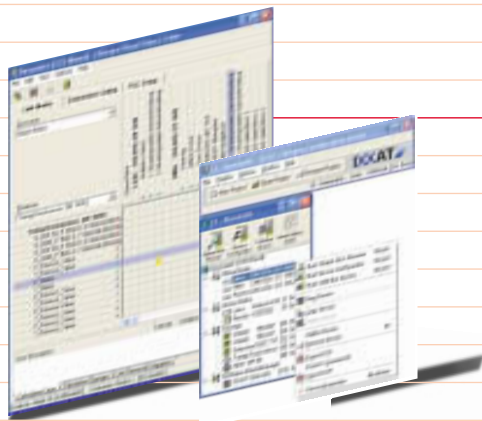

● **CANopen Configurator**

This software utility allows the CANopen network to be configured by integrating other third party devices with EDS files. A single file containing all the information may be imported into the OpenPCS programming system allowing access to the network variables through defined TAGs lists.



● **Autolink: the easy SCADA**

- Data acquisition and monitoring
- Process operation
- Extensive driver library
- Mimic and pre-formatted pages
- Real time and historical trending
- Powerful alarm handling
- Flexible configurable reporting
- Recipe management
- Security levels for operator access
- Ethernet TCP/IP networking
- Data exporting to commonly used databases.



● **Power Supply Units**

Input Voltage:	88..264 Vac
Output Voltage:	24V, ±1%
Output rated current:	2A (DR-45-24), 5A (DR-120-24)
Protection:	Over voltage, Overload, auto recovery
Temperature:	-10..+50 °C
Mounting:	DIN Rail
Dimensions:	97x78x67 mm (DR-45-24), 65x125x103 mm (DR-120-24)

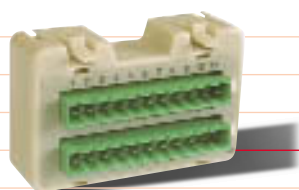

● **Cables and connectors**

Additional Terminal Block 2x11 poles.

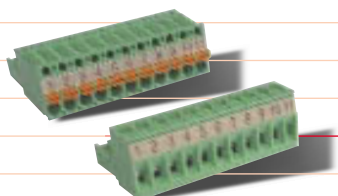

● Plug clamps available with screw or spring clamp option.

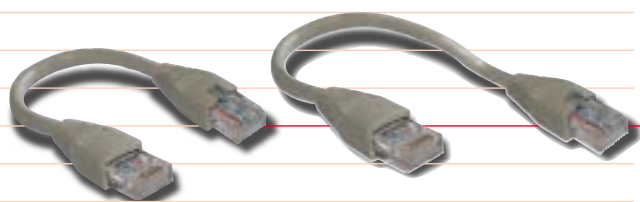

● RJ45 terminated cables are available with 14 cm or 22 cm standard lengths for easy daisy-chain connection of the I/O modules.

# Support and Services

## Support in selecting and configuring the system

A team of specialists is available to guide you when selecting and configuring components, to provide quotes and to recommend the best level of immediate and ongoing support.

## Internet

Visit [www.ascon.it](http://www.ascon.it) or [www.asconcorp.com](http://www.asconcorp.com) for details and information on the various levels of support offered for the SigmaPAC system.

The internet sites allow you to download numerous documents, such as technical charts, manuals, application examples, software, and more.

Furthermore, you may make requests and submit queries to Ascon technicians.

## Post-Sale Services

System specialists are available to help you use the system to the best of its capabilities. Our telephone assistance service will resolve most of your needs.

Ascon staff is also available on a contract basis to support your technicians onsite, wherever requested.

## Application Control Strategy

Upon request, Ascon may develop Control Strategies and Functional Macroblocks to resolve problems inherent in a unique or special application, or component thereof, in a simple and standard manner. These may then be replicated and modified by clients to adapt to similar applications.

## Installation Assistance

Ascon technicians are qualified in the installation of the SigmaPAC system. We work with the customer to assign the most qualified engineer to the application.

## Seminars, Courses, Training

Ascon regularly organizes seminars on the SigmaPAC system, courses regarding the products and applications, and training sessions aimed at developers and installers. Customized courses may also be created for client-specific applications.



S E R I E S

## ASCON spa

20021 Baranzate  
(Milano) Italy  
Via Falzarego, 9/11  
Tel. +39 02 333 371  
Fax +39 02 350 4243  
[www.ascon.it](http://www.ascon.it)  
[sales@ascon.it](mailto:sales@ascon.it)

## ASCON FRANCE

2 bis, Rue Paul Henri Spaak  
ST. THIBAULT DES VIGNES  
F-77462 LAGNY SUR  
MARNE - Cedex  
Tél. +33 (0) 1 64 30 62 62  
Fax +33 (0) 1 64 30 84 98  
[ascon.france@wanadoo.fr](mailto:ascon.france@wanadoo.fr)

## AGENCE EST

Tél. +33 (3) 89 76 99 89  
Fax +33 (3) 89 76 87 03

## AGENCE SUD-EST

Tél. +33 (0) 4 74 27 82 81  
Fax +33 (0) 4 74 27 81 71

## ASCON CORPORATION

472, Ridgelawn Trail  
Batavia, Illinois 60510  
Tel. +1 630 482 2950  
Fax +1 630 482 2956  
[www.asconcorp.com](http://www.asconcorp.com)  
[info@asconcorp.com](mailto:info@asconcorp.com)

WORLDWIDE NETWORK OF  
DIRECT SALES CENTRES,  
DISTRIBUTORS AND VARs

## Europe

Belgium, Cyprus, Croatia,  
Czech Rep, Finland, France,  
Germany, Great Britain, Greece,  
Holland, Ireland, Norway, Portugal,  
Romania, Russia, Slovenia, Spain,  
Sweden, Switzerland, Turkey, Ukrain

## Americas

Argentina, Brazil, Chile, Colombia,  
Ecuador, Peru, United States

## Over the world

Australia, China, Hong Kong, India,  
Israel, Malaysia, New Zealand,  
Singapore, Taiwan, Thailand,  
South Africa & South East Africa

Distributor: